

AI LIGHTS LATI

COLLECTION

MENTOS MAGNETO

WALL

MENTOS MAGNETO

WALL



AI LIGHTS
LATTI

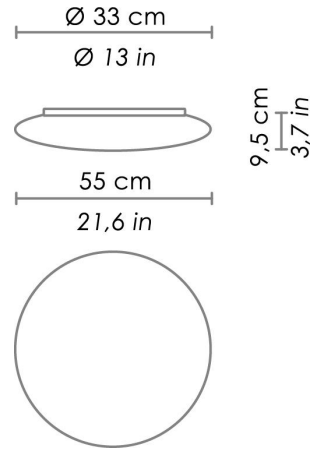

A collection of hanging, ceiling and wall lamps in satin finish triplex opal blown glass with a LED light source. Matt white painted metal parts. The Mentos collection has a special magnet fixing system for the glass component. In addition to simplifying and speeding up installation operations, this system is highly practical when standard maintenance is required.

LED 2700K - 4000K

CODE	COLOR
LD110403B-	White

DIMENSIONS AND HOLES	
Dimensions	Ø 55 cm / Ø 21,6 in

ILLUMINOTECHNICAL SPECIFICATIONS	
Source	LED
Type	SMD
Total Watt	41 W
Lumen LED board	3791 lm
Colour temperature	3000 K
CRI	>80
Lamp life	minimum 3 years guaranteed

ILLUMINOTECHNICAL SPECIFICATIONS	
Driver	included
Voltage	220-240 V
Frequency	50 - 60 HZ

PHYSICAL SPECIFICATIONS	
Thermal dissipation	passive

We reserve the right to change the specifications of our product. For the latest information on the product visit www.zafferanoitalia.com