

# zafferano

## LAMPES-À-PORTER

ISTRUZIONI D'USO | INSTRUCTIONS FOR USE | GEBRAUCHSANWEISUNG |  
MODE D'EMPLOI | INSTRUCCIONES DE USO

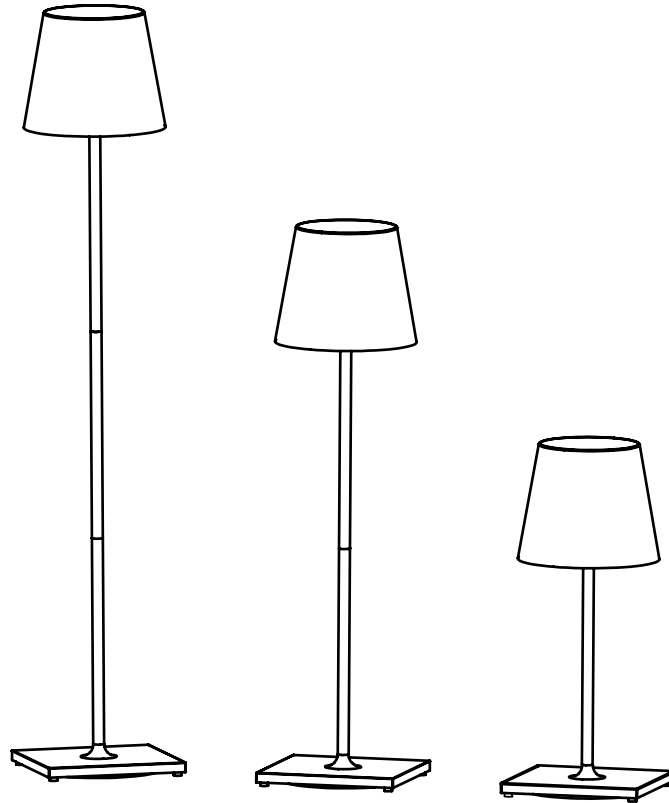

## poldina XXL pro

Lampada da tavolo e terra ricaricabile | Rechargeable table and floor lamp  
Aufladbare Tisch- und Stehlampe | Lampe de table et de sol rechargeable | Lámpara de mesa y suelo recargable



P 1-2



P 3-4



S 5-6



P 7-8



P 9-10



P 11-12



P 13



# poldina XXL pro

Lampada da tavolo e terra ricaricabile

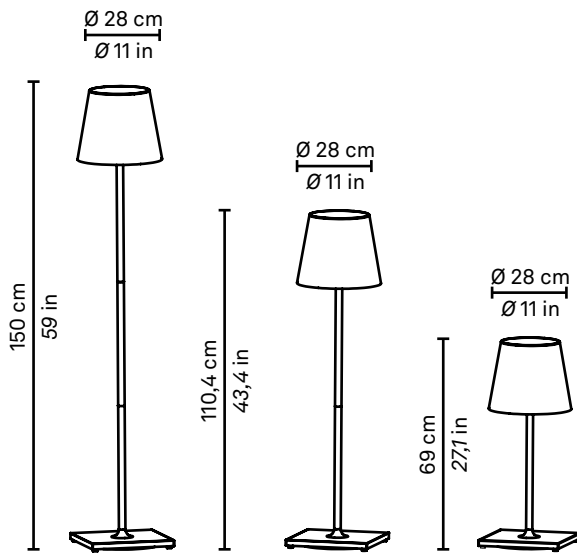

## LED DIMMER

10W • 510lm  
2700-3000K • IP54  
CRI>80 • 5Vdc max 1A

LD0360B3 bianco  
LD0360N3 grigio scuro  
LD0360R3 corten

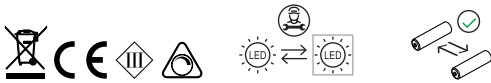

## INCLUSO



Base di ricarica a contatto

## NON INCLUSO



LD0340RA  
Caricatore multipresa USB (8xUSB)

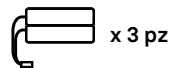

BAT04703706701900  
Pacco batteria sostitutiva



KIT00015000000100  
Scheda LED sostitutiva

## 1. Consigli d'uso:

Questo prodotto serve esclusivamente a scopi di illuminazione e:

A) Non deve essere esposto a pesanti carichi meccanici o forti contaminazioni; B) può essere installato e usato solo previo controllo delle condizioni del prodotto; verificare che non risulti sporco e non abbia subito danneggiamenti durante lo stoccaggio; C) l'installazione e la manutenzione vanno eseguite ad apparecchio spento; D) modifiche o manomissioni del prodotto e il non rispetto delle indicazioni riportate possono rendere l'apparecchio pericoloso; E) la lampada completamente assemblata (testa + struttura), raggiunge un grado di protezione IP54 che la rende idonea per uso esterno. Il solo corpo luce (testa) ha un grado di protezione IP20 e utilizzata singolarmente non è idonea per uso esterno; F) per la pulizia di tutte le superfici metalliche e plastiche utilizzare un panno morbido asciutto; G) la ditta Zafferano declina ogni responsabilità per danni causati da un proprio prodotto montato in modo non conforme alle istruzioni.

## 2. Dati tecnici della lampada:

- Potenza: 10 W
- Volt: DC 5 V
- Flusso luminoso: 510 lm
- Pacco batteria al litio inclusa (consultare sezione accessori inclusi); per le istruzioni di sostituzione del pacco batteria consultare il sito web [www.zafferanoitalia.com](http://www.zafferanoitalia.com); usare solamente batterie originali per la sostituzione.
- Ricarica: 20 h
- Durata batteria: 15 h
- Classe: III
- Grado di protezione: IP54
- CRI>80

## 3. Dati tecnici carica batterie:

- Base di ricarica: INPUT/OUTPUT 5Vdc - 1A; cavo USB 2 Mt.
- Caricatore: INPUT AC100-240V 50/60Hz; OUTPUT 5Vdc - 1A.
- La lampada funziona correttamente anche se collegata alla base di ricarica.
- Si raccomanda l'utilizzo del caricatore e della base di ricarica originale. In alternativa utilizzare un caricatore a 1A certificato.

## 4. Attenzione:

- Il piano d'appoggio della lampada non deve superare i 15° di inclinazione o rischia la caduta.
- La batteria ha la funzione di protezione da sovraccarico.
- Per preservare l'integrità della batteria si consiglia di mantenere la carica tra il 20% minimo e 80% massimo; se la lampada non viene utilizzata per lunghi periodi, si consiglia di procedere periodicamente ad un ciclo di carica/scarica del prodotto.
- Si prega di fare riferimento alle leggi locali per un corretto smaltimento e riciclaggio della batteria.

Visita il nostro sito per ulteriori informazioni, e aggiornamenti sulle caratteristiche del prodotto

DESIGNED BY ZAFFERANO SRL IN ITALY, MADE IN PRC.

Zafferano srl, Viale dell'Industria, 26 - 31055 Quinto di Treviso - TV - Italia

[www.zafferanoitalia.com](http://www.zafferanoitalia.com)

# ASSEMBLAGGIO E ISTRUZIONI D'USO



## INCLUSO

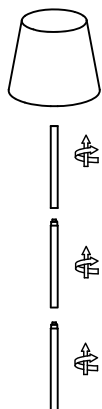
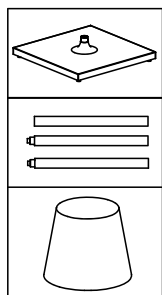

1

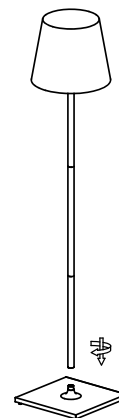

2

## ACCENSIONE

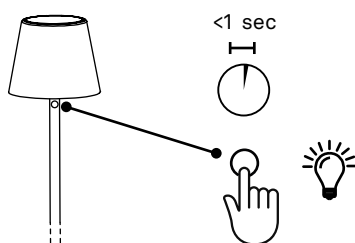

Rapido tocco sul touch per accendere la lampada

## SPEGNIMENTO

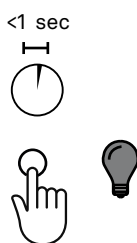

Rapido tocco sul touch per spegnere la lampada

## DIMMERAZIONE

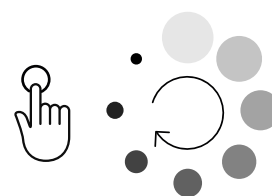

A lampada accesa, leggera pressione sul touch fino al raggiungimento della luminosità desiderata.  
Ad ogni accensione, l'intensità luminosa torna al 100%

## CAMBIO DELLA TEMPERATURA DI COLORE (2700 - 3000 K)

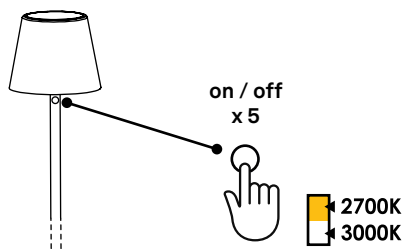

Accendere e spegnere la lampada per 5 volte consecutive; alla 5a accensione (10° tocco) la temperatura di colore verrà cambiata.  
N.B: tra un tocco e l'altro non devono passare più di 5 secondi

## RICARICA

Effettuare una carica completa della batteria prima del primo utilizzo. Per un corretto caricamento della lampada si consiglia di:

- 1) collegare il cavo USB al caricatore;
- 2) collegare la spina alla presa elettrica;
- 3) appoggiare la lampada sulla base di ricarica;
- 4) a carica completata scollegare la spina dalla presa elettrica e rimuovere il cavo USB

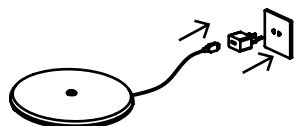

1-2

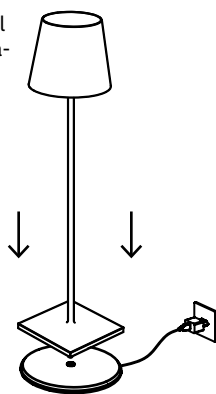

3

## LED DI SEGNALEZIONE

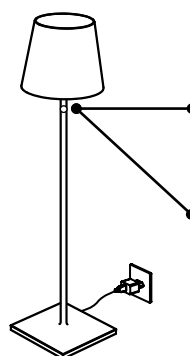

LED ROSSO  
ricarica in corso



LED VERDE  
batteria carica si consiglia di disconnettere dall'unità di ricarica



# poldina XXL pro

Rechargeable table and floor lamp

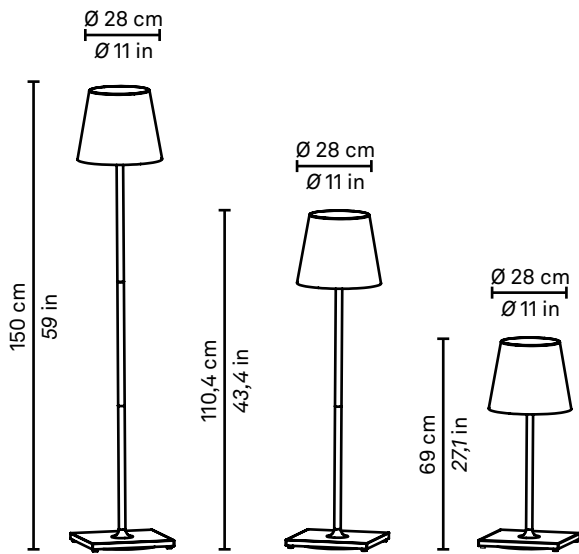

### LED DIMMER

10W • 510lm  
2700-3000K • IP54  
CRI>80 • 5Vdc max 1A

LD0360B3 white  
LD0360N3 dark grey  
LD0360R3 rust



### INCLUDED



Contact charging base

### NOT INCLUDED

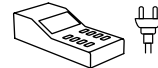

LD0340RA  
Multi-socket USB  
charger (8xUSB)

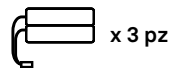

BAT04703706701900  
Replacement battery  
pack



KIT00015000000100  
Replacement LED board

## 1. Tips for use:

This product is exclusively for lighting purposes and:

A) It must not be exposed to heavy mechanical loads or contamination; B) It can be installed and used only after checking the state of the product; check that is not dirty and has not been damaged during storage; C) Installation and maintenance must be carried out when the appliance is switched off; D) Any alterations to the product, any tampering and any failure to comply with the instructions provided may make the appliance hazardous; When completely assembled (head + structure), the lamp has IP54 protection, which makes it ideal for outdoor use. The light fixture (head) alone has IP20 protection and is unsuitable for outdoor use on its own; F) All metal and plastic surfaces should be cleaned with a soft dry cloth; G) The company Zafferano shall not be held liable for any damage caused due to its products being assembled in any manner that does not comply with the instructions provided.

## 2. Technical data of the lamp:

- Power: 10 W
- Volt: DC 5 V
- Lumen lamp: 510 lm
- Lithium battery pack included (see section accessories included); for instructions about how to replace the battery pack, please consult the website: [www.zafferanoitalia.com](http://www.zafferanoitalia.com). Use only original batteries for replacement.
- Charge: 20 h
- Battery life: 15 h
- Class: III
- Protection rating: IP54
- CRI>80

## 3. Battery charger technical data:

- Contact charging base: INPUT/OUTPUT 5Vdc - 1A; cavo USB 2 Mt.
- Charger: INPUT AC100-240V 50/60Hz; OUTPUT 5Vdc - 1A.
- The lamp works correctly even when connected to the charging base.
- It is advisable to use the original charger and charging base. Alternatively, you can use a certified 1A charger.

## 4. Important:

- The support surface for the lamp must not exceed a 15° tilt or it will fall.
- The battery has an overload protection function.
- To preserve the integrity of the battery, we recommend keeping the charge between minimum 20% and maximum 80%; if the lamp is not used for long periods, it is advisable to regularly charge/discharge the product.
- Please refer to local laws for the proper disposal and recycling of the battery.

For more information and updates visit our website  
DESIGNED BY ZAFFERANO SRL IN ITALY, MADE IN PRC.

Zafferano srl, Viale dell'Industria, 26 - 31055 Quinto di Treviso - TV - Italia  
[www.zafferanoitalia.com](http://www.zafferanoitalia.com)

# ASSEMBLY AND INSTRUCTIONS FOR USE



## INCLUDED

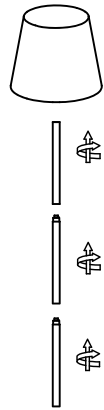
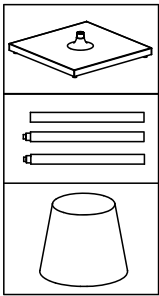

1

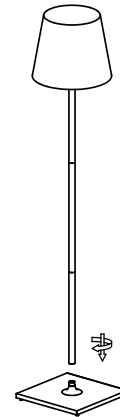

2

## SWITCHING ON

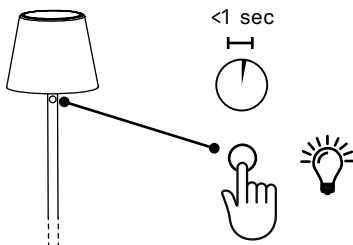

Quickly press the touch sensor to switch on the lamp

## SWITCHING OFF

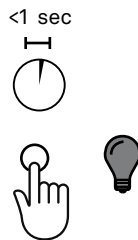

Quickly press the touch sensor to switch off the lamp

## DIMMER FUNCTION

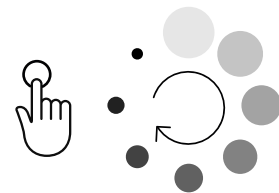

When the lamp is switched on, lightly press the touch sensor to obtain the desired brightness. Every time you turn it on, the light intensity returns to 100%

## CHANGING THE COLOUR TEMPERATURE (2700 - 3000 K)

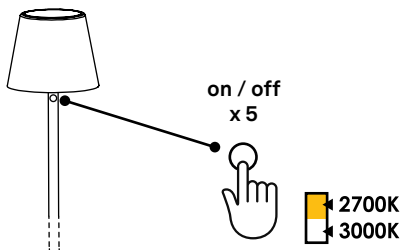

Turn the lamp on and off 5 times in succession; the 5th time you turn it on (10th touch), the colour temperature will be changed.

N.B. No more than 5 seconds must elapse between one touch and the next.

## CHARGE

Charge the battery before initial use. To correctly charge the lamp, we recommend that you:

- 1) Connect the USB cable to the adaptor;
- 2) Put the plug into the electrical socket;
- 3) Place the lamp on the charging base;
- 4) When fully charged, disconnect the plug from the electrical socket

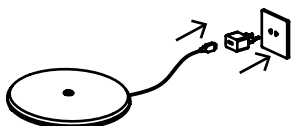

1-2

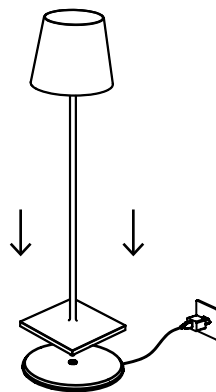

3

## INDICATOR LEDS

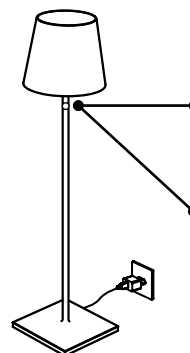

RED LED  
charging in progress



GREEN LED  
the battery is charged, it is advisable to disconnect it from the power charger



For more information and updates visit our website  
DESIGNED BY ZAFFERANO SRL IN ITALY, MADE IN PRC.

Zafferano srl, Viale dell'Industria, 26 - 31055 Quinto di Treviso - TV - Italia  
www.zafferanoitalia.com



# poldina XXL pro

Aufladbare Tisch- und Stehlampe

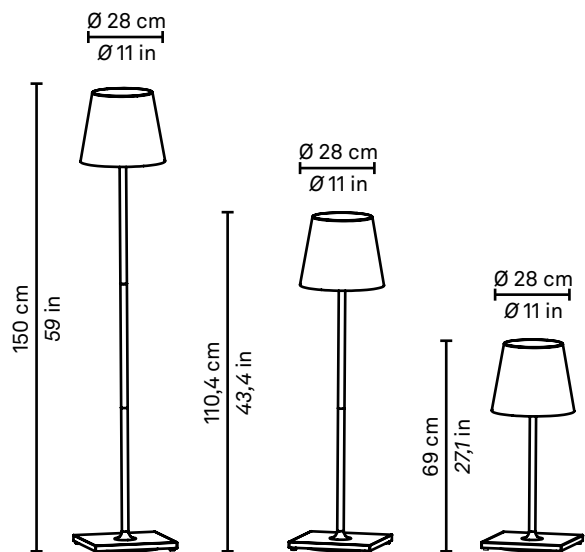

## LED DIMMER

10W • 510lm  
2700-3000K • IP54  
CRI>80 • 5Vdc max 1A

LD0360B3 weiss  
LD0360N3 dunkelgrau  
LD0360R3 corten

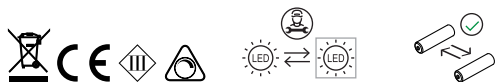

## BEILIEGEND



Aufladestation

## NICHT ENTHALTEN

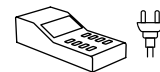

LD0340RA  
Ladegerät (8xUSB)

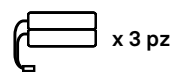

BAT04703706701900  
Ersatzakku



KIT00015000000100  
Ersatz-LED-Platine

## 1. Hinweise zur Verwendung:

Dieses Produkt dient ausschließlich zur Beleuchtung und:

A) Darf keinen starken mechanischen Belastungen oder starken Kontaminationen ausgesetzt werden; B) kann nur, nachdem der Zustand des Produkts kontrolliert wurde, installiert und verwendet werden; prüfen, dass es nicht schmutzig ist und während der Lagerung nicht beschädigt wurde; C) Das Gerät muss ausgeschaltet, installiert oder gewartet werden; D) Durch die Veränderung oder Manipulation des Produkts und die Nichteinhaltung dieser Anweisungen kann das Gerät gefährlich werden; E) Die fertig zusammengesetzte Lampe (Kopf + Unterbau) hat einen IP54-Schutzgrad, sodass sie auch im Freien verwendet werden kann. Der Leuchtkörper (Kopf) hat einen IP20-Schutzgrad und kann allein nicht im Freien verwendet werden; F) Zur Reinigung aller Metall- oder Plastikoberflächen ein trockenes, weiches Tuch verwenden; G) Die Firma Zafferano lehnt jede Verantwortung für Schäden ab, die durch eines ihrer Produkte, das nicht gemäß der gelieferten Anweisungen montiert wurde, entstehen.

## 2. Technische Daten der Lampe:

- Leistung: 10 W
- Volt: DC 5 V
- Absoluter Lichtstrom: 510 lm
- Eine Lithiumbatterie ist in der Lieferung enthalten (siehe Abschnitt Zubehör enthalten); zu den Anweisungen zum Auswechseln der Batterie schauen Sie bitte auf die Webseite [www.zafferanoitalia.com](http://www.zafferanoitalia.com). Verwenden Sie zum Austausch nur Originalbatterien.
- Aufladezeit: 20 h
- Batteriedauer: 15 h
- Klasse: III
- Schutzgrad: IP54
- CRI>80

## 3. Technische Daten des Ladegeräts:

- Aufladestation: INPUT/OUTPUT 5Vdc - 1A; cavo USB 2 Mt.
- Ladegerät: INPUT AC100-240V 50/60Hz; OUTPUT 5Vdc - 1A.
- Die Lampe funktioniert auch dann korrekt, wenn sie an die Ladestation angeschlossen ist.
- Wir raten dazu, das mitgelieferte Original-Aufladegerät und die Original-Aufladestation zu verwenden. Als Alternative ein zertifiziertes 1A-Aufladegerät verwenden.

## 4. Achtung:

- Die Standfläche der Lampe darf keine höhere Neigung als 15° besitzen, sonst fällt diese um.
- Die Batterie sorgt dem Überlastungsschutz.
- Um die Lebensdauer des Akkus zu erhalten, sollte sein Ladestand zwischen 20 und 80 Prozent liegen. Wenn die Lampe lange Zeit nicht benutzt wird, sollte der Akku regelmäßig ent- und wieder aufgeladen werden.
- Die Batterie muss entsprechend der geltenden, lokalen Vorschriften zur Abfallentsorgung und -wiederverwertung behandelt werden.

Zu weiteren Informationen und Aktualisierungen der Produktkennzeichen besuchen Sie bitte unsere Webseite.

DESIGNED BY ZAFFERANO SRL IN ITALY, MADE IN PRC.

Zafferano srl, Viale dell'Industria, 26 - 31055 Quinto di Treviso - TV - Italia  
[www.zafferanoitalia.com](http://www.zafferanoitalia.com)

# MONTAGE UND GEBRAUCHSANWEISUNG



## BEILIEGEND

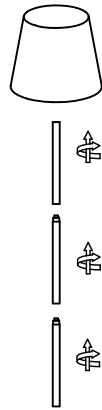
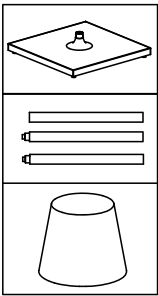

1

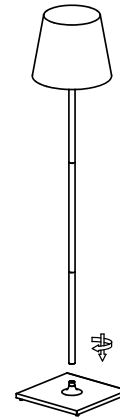

2

## EINSCHALTEN

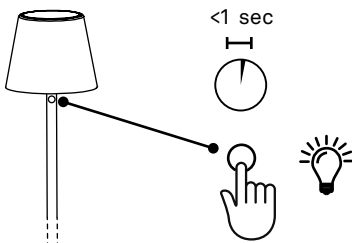

Die Taste kurz drücken und die Lampe geht an

## AUSSCHALTEN

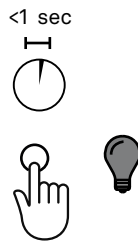

Die Taste kurz drücken und die Lampe geht aus

## LICHT DIMMEN

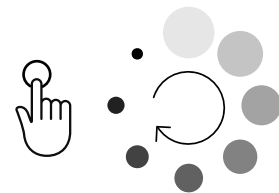

Wenn die Lampe an ist, leicht auf den Taster drücken, bis die gewünschte Helligkeit erreicht wurde. Sobald das Gerät erneut eingeschaltet wird, ist die Lichtstärke wieder 100%.

## ÄNDERN DER FARBTEMPERATUR (2700 - 3000 K)

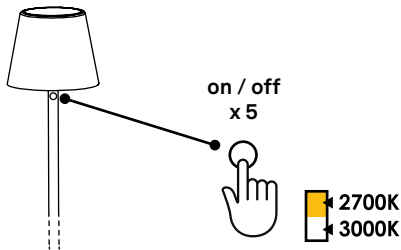

Die Lampe 5 Mal hintereinander an- und ausstellen;  
Beim 5. Anschalten (10. Berührung) ändert sich die Farbtemperatur.  
WICHTIG: Zwischen den Berührungen dürfen nicht mehr als 5 Sekunden vergehen.

## AUFLADEN

Die Batterie des Produkts vor dem ersten Gebrauch vollkommen aufladen. Um die Lampe korrekt aufzuladen, sollte man:

- 1) Das USB-Kabel an den Adapter anschließen;
- 2) Den Stecker in die Steckdose stecken;
- 3) Die Lampe auf die Aufladestation stellen;
- 4) Wenn die Lampe aufgeladen ist, den Stecker aus der Steckdose ziehen und das USB-Kabel von der Lampe trennen

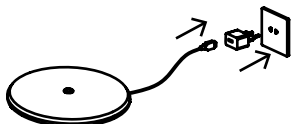

1-2

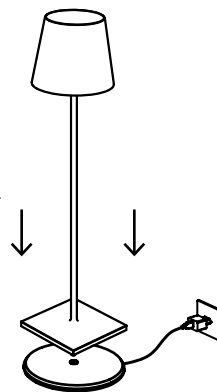

3

## LEDANZEIGE

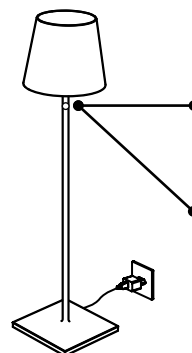

ROT LED  
Wird aufgeladen



LED GRÜN  
Die Batterie ist aufgeladen.  
Das Gerät sollte von der Ladeeinheit getrennt werden



Zu weiteren Informationen und Aktualisierungen der Produktkennzeichen besuchen Sie bitte unsere Webseite.

DESIGNED BY ZAFFERANO SRL IN ITALY, MADE IN PRC.

Zafferano srl, Viale dell'Industria, 26 - 31055 Quinto di Treviso - TV - Italia

www.zafferanoitalia.com



# poldina XXL pro

Lampe de table et de sol rechargeable

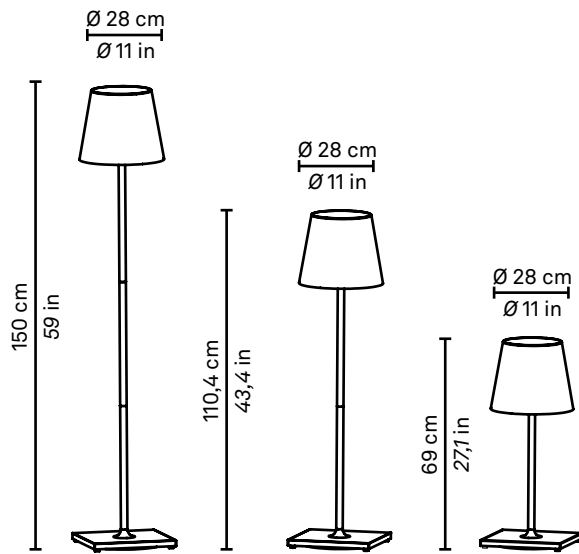

## LED DIMMER

10W • 510lm  
2700-3000K • IP54  
CRI>80 • 5Vdc max 1A

LD0360B3 blanc  
LD0360N3 gris foncé  
LD0360R3 corten

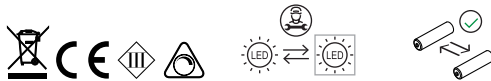

## INCLUS



Station de charge par contact

## NON INCLUS

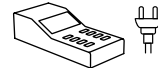

LD0340RA  
Station de charge multiple (8xUSB)

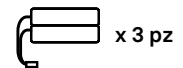

BAT04703706701900  
Batterie de remplacement



KIT00015000000100  
Carte LED de remplacement

## 1. Conseils d'utilisation:

Ce produit sert exclusivement pour éclairer et:

A) Ne doit pas être exposé à de lourdes charges mécaniques ou à de fortes contaminations; B) Peut être installé et utilisé uniquement après avoir contrôlé les conditions du produit; vérifier s'il n'est pas sale et s'il n'a pas subi de dommages durant le stockage; C) L'installation et l'entretien doivent être effectués lorsque l'appareil est éteint; D) Les modifications ou les altérations du produit et le non-respect des indications fournies peuvent rendre l'appareil dangereux; E) la lampe complètement assemblée (tête + structure), atteint un degré de protection IP54 qui lui permet d'être utilisée à l'extérieur. Seul le corps éclairage (tête) possède un degré de protection IP20 et, si elle est utilisée toute seule, elle n'est pas adaptée pour une utilisation à l'extérieur; F) Pour le nettoyage de toutes les surfaces métalliques et plastiques, utiliser un chiffon souple et sec; G) La société Zafferano décline toute responsabilité pour les dommages provoqués par un produit monté de manière non conforme par rapport aux instructions.

## 2. Données techniques de la lampe:

- Puissance: 10 W
- Voltage: DC 5 V
- Flux lumineux: 510 lm
- Batteries au lithium inclus (voir rubrique accessoires inclus); visiter le site [www.zafferanoitalia.com](http://www.zafferanoitalia.com) pour avoir les indications de son remplacement. N'utilisez que des piles d'origine pour le remplacement.
- Recharge: 20 h
- Durée de la batterie: 15 h
- Classe: III
- Degré de protection: IP54
- CRI>80

## 3. Données techniques du chargeur de batterie:

- Station de charge par contact: INPUT/OUTPUT 5Vdc - 1A; cavo USB 2 Mt.
- chargeur: INPUT AC100-240V 50/60Hz; OUTPUT 5Vdc - 1A.
- La lampe fonctionne correctement même lorsqu'elle est connectée à la base de chargement.
- Il est conseillé d'utiliser le chargeur et la station de charge d'origine. En alternative, utiliser un chargeur à 1A certifié.

## 4. Attention:

- Le plan d'appui de la lampe ne doit pas dépasser 15° d'inclinaison, sinon elle risque de tomber.
- La batterie est munie de la fonction de protection contre les surcharges.
- Pour préserver l'intégrité de la batterie, il est conseillé de maintenir la charge entre 20% minimum et 80% maximum; si la lampe n'est pas utilisée pendant de longues périodes, il est conseillé de procéder périodiquement à un cycle de charge/décharge du produit.
- Se référer aux lois locales pour une élimination correcte et le recyclage de la batterie.

Visitez notre site pour recevoir d'autres informations et des mises à jour sur les caractéristiques du produit

DESIGNED BY ZAFFERANO SRL IN ITALY, MADE IN PRC.

Zafferano srl, Viale dell'Industria, 26 - 31055 Quinto di Treviso - TV - Italia

[www.zafferanoitalia.com](http://www.zafferanoitalia.com)



# ASSEMBLAGE ET MODE D'EMPLOI



## INCLUS

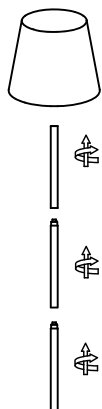
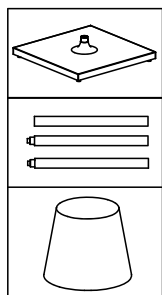

1

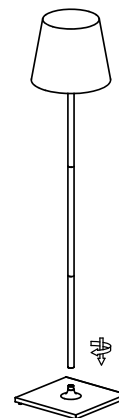

2

## ALLUMAGE

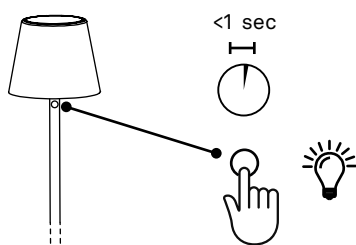

Presson rapide sur le touch pour allumer la lampe

## COUPURE

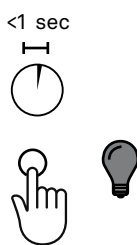

Presson rapide sur le touch pour éteindre la lampe

## VARIATION DE L'INTENSITE LUMINEUSE

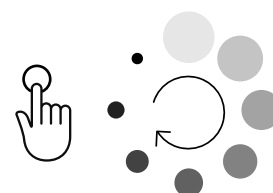

Lorsque la lampe est allumée, appuyer légèrement sur le touch tant que la luminosité désirée n'est pas atteinte. Lors de chaque allumage, l'intensité lumineuse est réglée à 100%

## CHANGEMENT DE LA TEMPERATURE DE COULEUR (2700 - 3000 K)

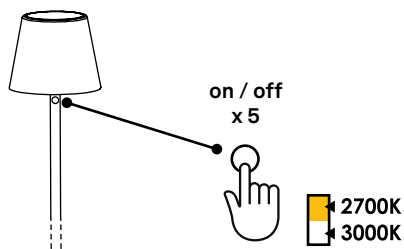

Allumer et éteindre la lampe 5 fois de suite; au 5<sup>ème</sup> allumage (10<sup>ème</sup> toucher), la température de couleur changera.  
N.B: il ne doit pas s'écouler plus de 5 secondes entre un toucher et l'autre

## RECHARGE

Recharger complètement la batterie avant la première utilisation. Pour recharger la lampe correctement, il est conseillé de:

- 1) brancher le câble USB à l'adaptateur;
- 2) insérer la fiche dans la prise de courant;
- 3) placer la lampe sur la station de charge;
- 4) lorsque la lampe est rechargée, retirer la fiche de la prise de courant et enlever le câble USB

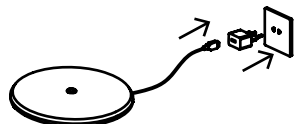

1-2

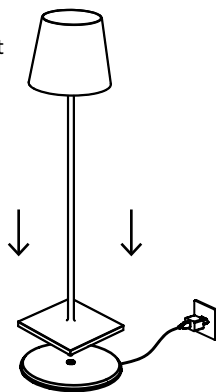

3

## LED DE SIGNALISATION

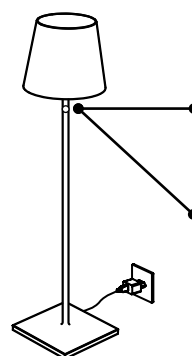

LED ROUGE  
recharge en cours



LED VERT  
batterie chargée, il est conseillé de la débrancher de l'unité de recharge



# poldina XXL pro

Lámpara de mesa y suelo recargable

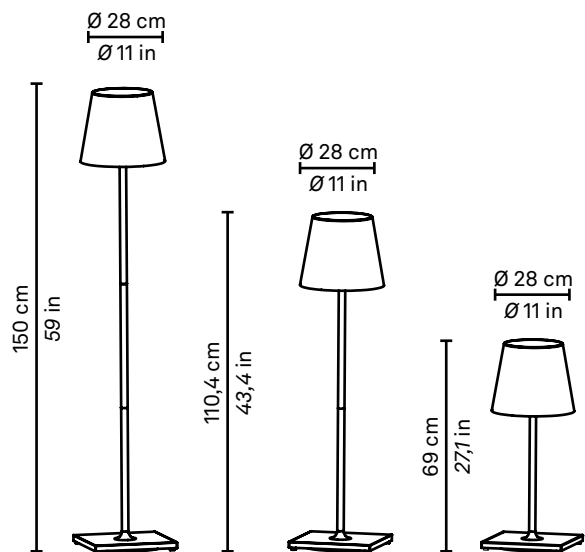

## LED DIMMER

10W • 510lm  
2700-3000K • IP54  
CRI>80 • 5Vdc max 1A

LD0360B3 blanco  
LD0360N3 gris oscuro  
LD0360R3 corten

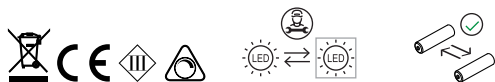

## INCLUIDO



Base de recarga con contacto

## NO INCLUIDO

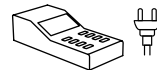

LD0340RA  
Cargador múltiple USB (8xUSB)

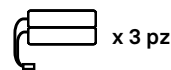

BAT04703706701900  
Paquete batería sustitutiva



KIT00015000000100  
Tablero LED de repuesto

## 1. Consejos de uso:

Este producto debe utilizarse exclusivamente para iluminación y:

A) No debe ser expuesto a cargas mecánicas pesadas o contaminaciones fuertes; B) solo puede ser instalado y utilizado previo control de las condiciones del producto; verificar que no resulte estar sucio y no ha haya sido dañado durante el almacenamiento; C) la instalación y el mantenimiento deben realizarse con el aparato apagado; D) las modificaciones o las manipulaciones del producto y el incumplimiento de las indicaciones mostradas pueden hacer que el aparato sea peligroso; E) la lámpara completamente montada (cabezal + estructura), alcanza un grado de protección IP54 que hace que sea idónea para uso en exteriores. Solo el cuerpo de la luz (cabezal) tiene un grado de protección IP20 y si la lámpara se utiliza individualmente no es adecuada para uso en exteriores; F) para la limpieza de todas las superficies metálicas y de plástico utilizar un paño suave y seco; G) La empresa Zafferano declina cualquier responsabilidad por los daños causados por un producto suyo montado de manera no conforme con las instrucciones.

## 2. Datos técnicos de la lámpara:

- Potencia: 10 W
- Voltios: DC 5 V
- Flujo luminoso: 510 lm
- Batería de litio incluida: (18650/2200mAh\*2)x3 pc; para las instrucciones de sustitución de la batería consulte el sitio web [www.zafferanoitalia.com](http://www.zafferanoitalia.com). Para la sustitución se recomienda el uso de una batería original.
- Recarga: 20 h
- Duración de la batería: 15 h
- Clase: III
- Grado de protección: IP54
- CRI>80

## 3. Datos técnicos del cargador de batería:

- Base de recarga con contacto: INPUT/OUTPUT 5Vdc - 1A; cavo USB 1.2 Mt.
- Cargador: INPUT AC100-240V 50/60Hz; OUTPUT 5Vdc- 1A.
- La lámpara funciona correctamente incluso cuando está conectada a la base de carga.
- Se recomienda el uso del cargador y de la base de recarga original. Alternativamente utilizar un cargador de 1A certificado.

## 4. Atención:

- La superficie de apoyo de la lámpara no debe superar los 15° de inclinación para evitar su caída.
- La batería tiene la función de protección ante sobrecargas.
- Para preservar la integridad de la batería se aconseja mantener la carga entre un mínimo del 20% y un máximo del 80%; si la lámpara no se utiliza durante períodos prolongados se aconseja realizar periódicamente un ciclo de carga/descarga del producto.
- Remítase a las normativas de ley locales para una eliminación y reciclaje correctos de la batería.

Visite nuestro sitio web para más informaciones y actualizaciones sobre las características del producto

DESIGNED BY ZAFFERANO SRL IN ITALY, MADE IN PRC.

Zafferano srl, Viale dell'Industria, 26 - 31055 Quinto di Treviso - TV - Italia

[www.zafferanoitalia.com](http://www.zafferanoitalia.com)

# MONTAJE E INSTRUCCIONES DE USO



## INCLUIDO

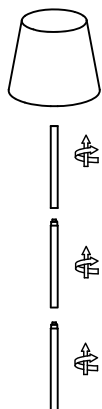
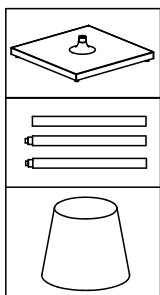

1

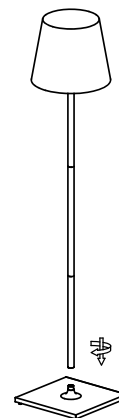

2

## ENCENDIDO

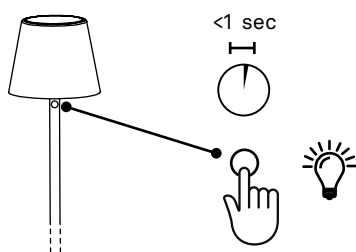

Toque rápido en la pantalla táctil para encender la lámpara

## APAGADO

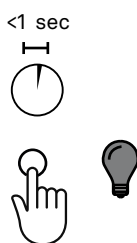

Toque rápido en la pantalla táctil para apagar la lámpara

## OSCURECIMIENTO

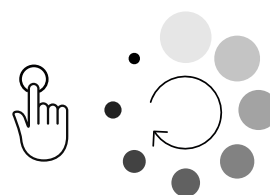

Con la lámpara encendida, apretar ligeramente en la pantalla táctil hasta lograr el brillo deseado. En cada encendido la intensidad luminosa vuelve al 100%

## CAMBIO DE LA TEMPERATURA DE COLOR (2700 - 3000 K)

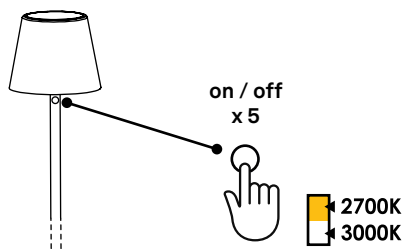

Encender y apagar la lámpara 5 veces consecutivas; en el 5º encendido (10º toque) cambiará la temperatura de color  
Nota: entre un toque y el otro no deben pasar más de 5 segundos

## RECARGA

Realizar una carga completa de la batería antes de usarla por primera vez. Para una carga correcta de la lámpara se aconseja:

- 1) conecte el cable USB al cargador;
- 2) conecte el enchufe a la toma de corriente;
- 3) apoyar la lámpara en la base de recarga;
- 4) una vez completada la carga, retire el enchufe de la toma eléctrica y retire el cable USB

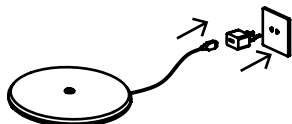

1-2

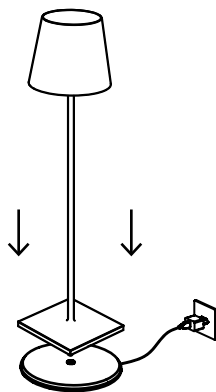

3

## LED DE SEÑALIZACIÓN

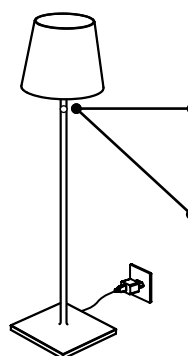

LED ROJO  
recarga en curso



LED VERDE  
batería cargada, se aconseja desconectar de la unidad de recarga



INCLUSI / INCLUDED / BEILIEGEND / INCLUS / INCLUIDO

(IT) Base di ricarica a contatto singola

(UK) Single-contact charging station

(DE) Einzel-Kontaktladestation

(FR) Station de charge à contact simple.

(ES) Base de recarga con contacto individual

INPUT: 5Vdc max 1A  
OUTPUT: 5Vdc max 1A



INPUT: AC100-240V  
50/60Hz  
OUTPUT: 5Vdc max 1A

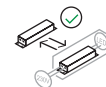

NON INCLUSI / NOT INCLUDED / NICHT ENTHALTEN / NON INCLUS / NO INCLUIDO

LD0340RA

(IT) Caricatore multipresa USB (8xUSB)

(UK) Multi-socket USB charger (8xUSB)

(DE) Ladegerät (8xUSB)

(FR) Station de charge multiple (8xUSB)

(ES) Cargador múltiple USB (8xUSB)

INPUT: AC100-240V  
50/60Hz  
OUTPUT: 5Vdc max 8A

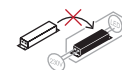
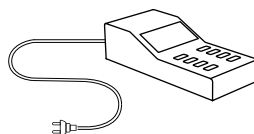

BAT04703706701900\*

(IT) Pacco batteria sostitutiva

(UK) Replacement battery pack

(DE) Ersatzakku

(FR) Batterie de remplacement

(ES) Paquete batería sustitutiva

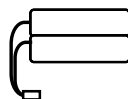

**BAT04703706701900\* x 3 pz**

Scansiona il codice QR per vedere come sostituire le batterie esauste della tua lampada./  
Scan the QR code to see how to replace the exhausted batteries of your lamp./  
Scannen Sie den QR-Code, um herauszufinden, wie Sie die verbrauchten Batterien Ihrer Lampe ersetzen können./  
Scannez le code QR pour voir comment remplacer les piles épuisées de votre lampe./  
Escanee el código QR para ver cómo reemplazar las baterías agotadas de su lámpara./



- Ⓜ Scheda LED sostitutiva
- ⓊⓀ Replacement LED board
- Ⓛⓔ Ersatz-LED-Platine
- ⓕⓇ carte LED de remplacement
- ⓔⓈ tablero LED de repuesto

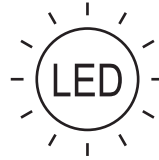

For qualified personnel:



**KIT00015000000100**

Scansiona il codice QR per vedere come sostituire la scheda LED esausta della tua lampada./

Scan the QR code to see how to replace the LED board of your lamp./

Scannen Sie den QR-Code, um herauszufinden, wie Die Lampen-LED-Platine kann ausgetauscht werden./

Scannez le code QR pour voir comment remplacer la carte LED de la lampe./

Escanee el código QR para ver cómo reemplazar la placa LED de la lámpara.





Le batterie ricaricabili con il loro utilizzo sono soggette ad usura. La vita delle batterie, il cui standard è di circa 450 ricariche, può essere ridotta da alcuni fattori come:

- ① la modalità non corretta di ricarica (la lampada va ricaricata quando è scarica: circa il 10% della sua autonomia residua);
- ② lunghi periodi di stazionamento senza utilizzo;
- ③ lunghi periodi di stazionamento su base di ricarica in tensione anche se la lampada risulta carica;
- ④ l'utilizzo di accessori non originali per la ricarica;

⑤ l'esposizione del prodotto a temperature molto alte o molto fredde. Quando le lampade non si ricaricano più o l'autonomia dopo la ricarica risulta molto ridotta, le batterie devono essere sostituite. I ricambi delle lampade ricaricabili Zafferano sono disponibili a catalogo e identificati con apposito codice. La garanzia sulle batterie è valida solo per difetti di fabbricazione, che si possono verificare dopo il primo utilizzo.



All rechargeable batteries are subject to wear when used. The life of batteries, which can generally be recharged 450 times, may be reduced by certain factors:

- ① incorrect recharging mode (the lamp must be recharged when it is flat: about 10% of its remaining autonomy);
- ② when left unused for a long time;
- ③ when left for a long time on a live recharging base even if the lamp is recharged;
- ④ when non-original accessories are used for recharging;

⑤ when the product is exposed to very high or very low temperatures. When the lamps no longer recharge or their autonomy after recharging is very short, the batteries must be replaced. Spare parts for Zafferano rechargeable lamps can be found in the catalogue and identified by a special code. The warranty for batteries is only valid for manufacturing defects, which may occur after initial use.



Wiederaufladbare Akkus unterliegen durch ihren Gebrauch Verschleiß. Die Lebensdauer der Akkus, deren Standard bei ca. 450 Aufladungen liegt, kann durch bestimmte Faktoren verkürzt werden, z. B.:

- ① falscher Auflademodus (die Lampe sollte aufgeladen werden, wenn sie entladen ist: bei ca. 10 % ihrer verbleibenden Ladung);
- ② langes Lagern ohne Nutzung;
- ③ langes Stehen auf der stromführenden Ladestation, auch wenn die Lampe aufgeladen ist;

④ Verwendung von nicht Original-Ladestationen;  
⑤ das Produkt sehr hohen oder sehr kalten Temperaturen auszusetzen. Wenn sich die Lampen nicht mehr aufladen lassen oder die Autonomie nach dem Aufladen stark reduziert ist, müssen die Akkus ersetzt werden. Ersatzteile für Zafferano-Akkuleuchten sind im Katalog erhältlich und mit dem entsprechenden Code gekennzeichnet. Die Garantie auf die Akkus gilt nur bei Produktionsfehlern, die nach dem ersten Gebrauch auftreten können.



Les batteries rechargeables sont sujettes à l'usure à la suite de leur utilisation. La durée de vie des batteries, dont le standard est d'environ 450 cycles de charge, peut être réduite par certains facteurs comme:

- ① une modalité de charge incorrecte (la lampe doit être rechargée lorsqu'elle est déchargée: environ 10% de son autonomie résiduelle);
- ② de longues périodes de pause sans utilisation;
- ③ de longues périodes de pause sur la station de charge sous tension, même si la lampe est rechargée;
- ④ l'utilisation d'accessoires non originaux pour la

charge;  
⑤ l'exposition du produit à des températures très élevées ou très basses. Les batteries doivent être remplacées lorsque les lampes ne se rechargent plus ou bien lorsque l'autonomie est très réduite après le cycle de charge. Les pièces de rechange des lampes rechargeables Zafferano sont disponibles dans le catalogue et identifiées par un code spécifique. La garantie sur les batteries est valable uniquement pour les défauts de fabrication constatés après leur première utilisation.



Las baterías recargables, con su uso, están sujetas a desgaste. La vida de las baterías, cuya duración es de unas 450 recargas, puede verse reducida por factores tales como:

- ① una modalidad de carga incorrecta (la lámpara se recarga cuando está descargada: aproximadamente el 10% de su autonomía restante);
- ② periodos prolongados sin usarla;
- ③ periodos prolongados colocada en la base de carga en tensión, incluso si la lámpara resulta estar cargada;
- ④ el uso de accesorios no originales para la carga;

⑤ la exposición del producto a temperaturas muy altas o muy bajas. Cuando las lámparas ya no se recargan o la autonomía después de la recarga resulta verse muy reducida, las baterías deben ser sustituidas. Los recambios de las lámparas recargables Zafferano están disponibles en el catálogo e identificados con el código correspondiente. La garantía de las baterías sólo es válida en caso de defectos de fabricación que puedan ocurrir después del primer uso.



**zafferano**  
LAMPES-À-PORTER

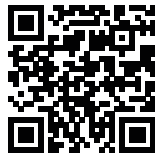

**Zafferano srl**

Viale dell'Industria, 26  
31055 - Quinto di Treviso - Italia  
T +39 0422 470507  
F +39 0422 470400  
sales@ailatilight.com  
www.zafferanoitalia.com